

Nombre: _____

Colorea del mismo color los objetos que sirvan para lo mismo.

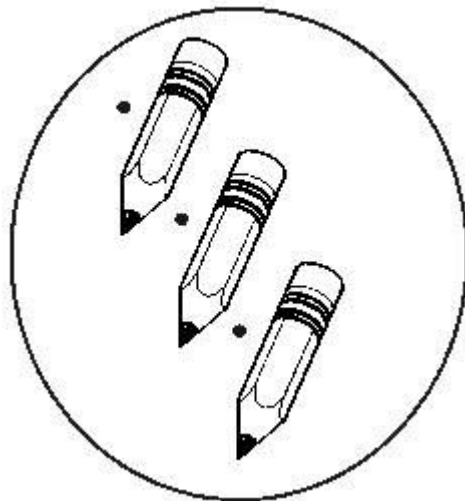

CORRESPONDENCIA

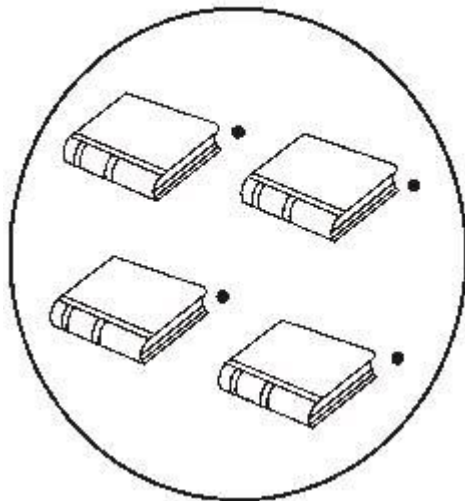
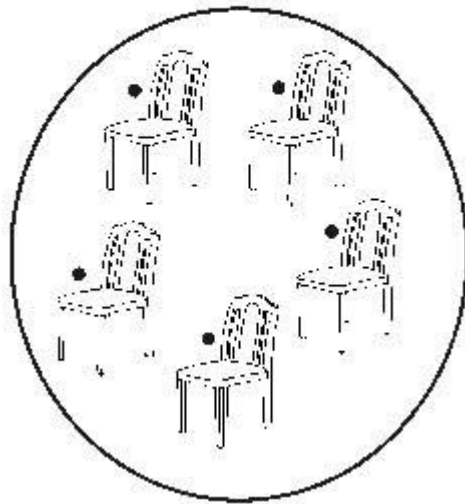
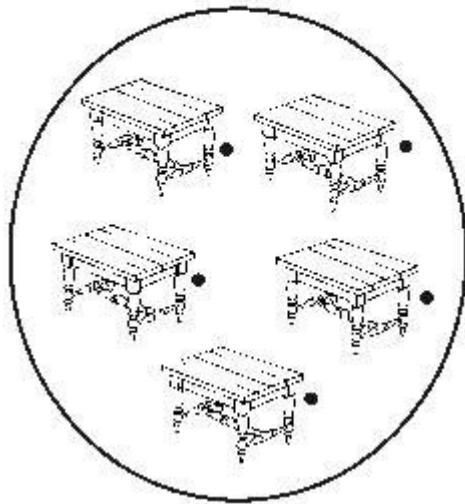

Une con una línea.

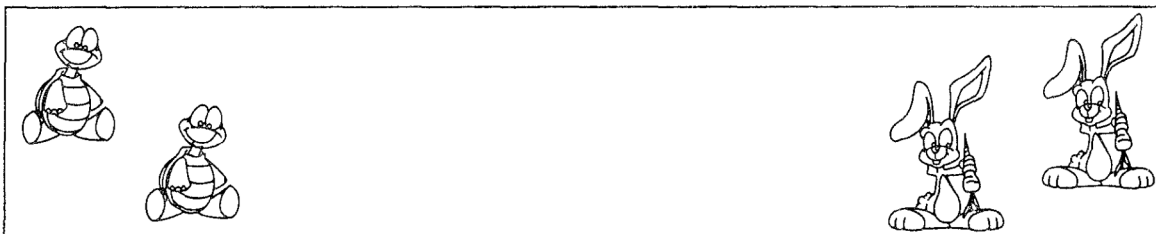
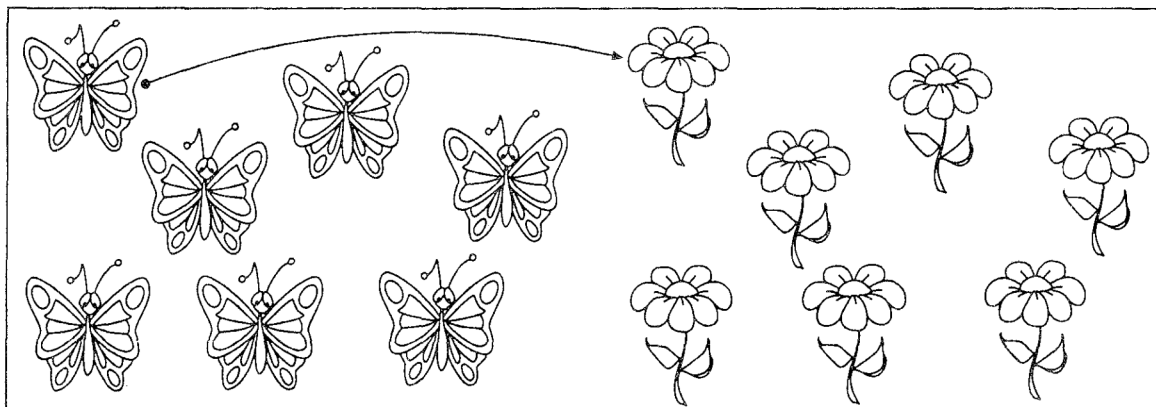

A cada niño pégale dos zapatos.

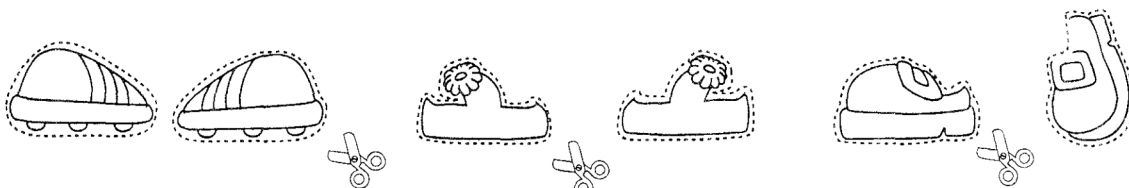

Correspondencia Uno a Uno
Correspondencia Dos a Dos



Semana 5

Ficha 17

Correspondencias lógicas



Une los dibujos que corresponden y colorea.

correspondencia uno a uno

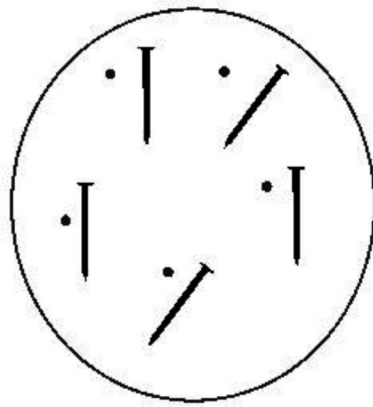
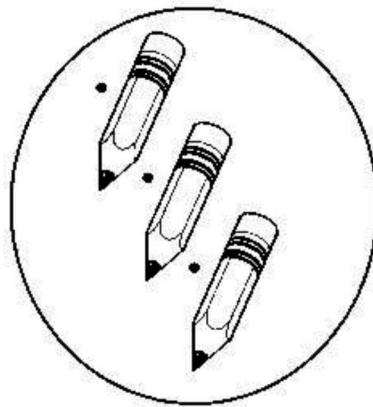
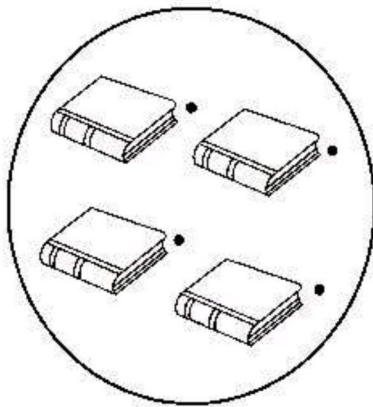

Nombre: _____

Relaciona cada animal con su silueta.

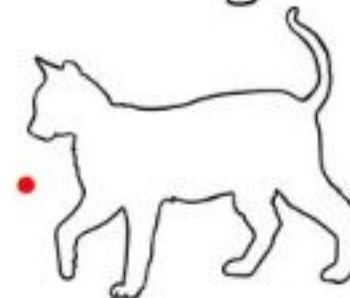
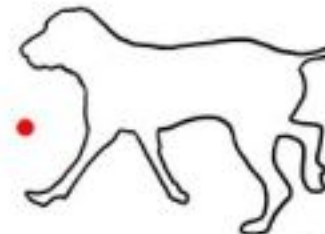
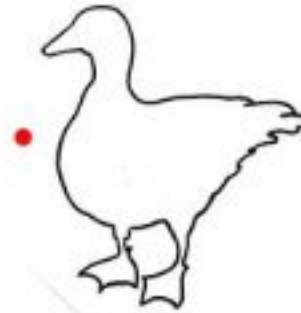
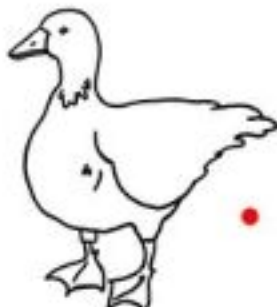
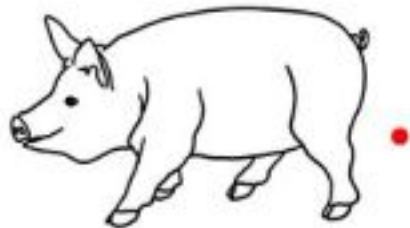
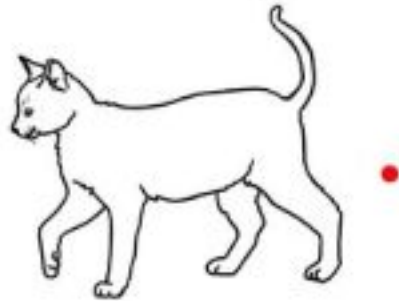
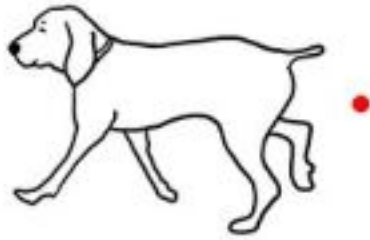

Nombre: _____

Tacha lo que no corresponde en cada fila y colorea los demás.

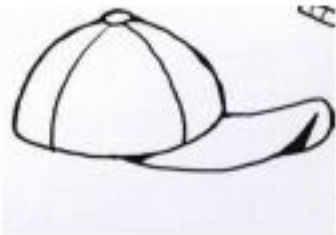
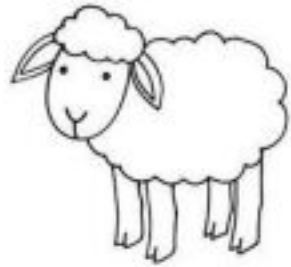

Nombre: _____

Une cada objeto de arriba con el que corresponda abajo y colorea las parejas del mismo color.

